

# HEISEN ELECTRICAL

WWW.HAISENTJ.COM

## 产品选型手册 >

Product Selection Guide

HSOUP 单相自复式过欠压保护器

HSOUP resettable over-voltage protection

HSOUP resettable over-voltage protection

HSOUP 三相自复式过欠压保护器



海森(天津)电气设备有限公司  
Heisen (Tianjin) Electric Equipment Co., Ltd.

## 企业简介

COMPANY BRIEF INTRODUCTION



海森（天津）电气设备有限公司重组后是一家股份制高新技术企业，隶属诺尔集团（天交所股票代码 000041），致力于低压电器元器件的研发、设计、制造、销售的专业公司。是双电源自动转换开关集中监控系统的开拓者。工厂占地面积 20000 平米，拥有员工 200 余人，专业研发团队 20 余人，专业技术人员 80 余人，公司拥有先进的技术装备和国内一流的制造工艺，有国际先进水平的高低温试验箱、步入式高温老化实验室、数控机床生产线、大型高速冲床和压力机等，先进的自动化生产及检测设备。公司设有独立的研发中心，一直注重产品研发及技术储备，不断加强同国际知名企业和国家级科研机构的科技交流与合作，凭借几十年从事电气科研的专家班底和具有丰富软件系统设计、实践操作经验的工程师，经潜心研究，研制出具有国际先进水平的 HSTS 系列静态转换开关，第七代 HSTP7 系列双电源自动转换开关，第四代 HSOUF 系列自恢复式过欠压保护器，第五代 HSCP5 系列控制与保护开关，HSBP 系列 SPD 后备保护装置，HSDP 电涌保护器，等等。具有雄厚的技术力量和强大的生产能力，从每一个小元件到合格产品出厂都是独立完成，产品始终处于行业领军地位。

公司率先通过 ISO9001：2000 国际质量管理体系认证，产品通过 3C 强制认证和测试。建立了完善的质量管理制度，努力追求产品的高质量、高品位。公司获得众多荣誉及专利，被认定为天津市重点高新技术企业，在国内建有 8 大区域销售中心，10 多个城市设有办事处，已建成覆盖全国的营销网络。

Hesse (Tianjin) electric equipment Co., a tech enterprises, group membership (NOC electrical components R & D, design, man centralized monitoring system of double square meters, has more than 200 employees than 80 professional and technical personnel domestic first-class manufacturing technology advanced level of walk-in high temperature and high speed punch press automation has an independent R & D center, has been strengthening scientific and technological enterprises and national research institutes engaged in electrical engineers design, and system, through painstaking research, developed static switch, switch seventh generation HSTP7 of HSOUF series self recovery type over-voltage control and protective switch, HSBP series With strong technical force and strong production products, the factory is completed independently. The company took the lead through ISO9001:2000 the product through the 3C compulsory certification system, and strive to pursue high-quality patents, has been identified as the key high-tech centers, more than 10 cities with offices, h



## 硬件设备，品质的保证

HARDWARE EQUIPMENT, QUALITY ASSURANCE



Co., after the reorganization of the company is a joint-stock high- (Noel day exchange stock code 000041), dedicated to low-voltage manufacturing and sales of professional firms. It is the pioneer of public power automatic switch. The factory covers an area of 20000 employees, professional R & D team of more than 20 people, more personnel, the company has advanced technology and equipment and technology, high and low temperature test box, with the international temperature aging laboratory, CNC machine tool production line, large automation, advanced production and testing equipment. The company has been focusing on product development and technical reserves, technological exchanges and cooperation with international well-known institutions and experts with decades of scientific research team, and has rich experience of the practice of the operation of software, developed with the international advanced the level of HSTS series on HSTP7 series dual power automatic transfer, the fourth generation over-voltage protection device, the fifth generation of HSCP5 series series SPD backup protection device, HSDP surge protector, etc.. Long production capacity, from each small components to qualified independently, the product has always been in the industry leader. ISO9001: 2000 international quality management system certification, factory certification and testing. Establish a sound quality management quality products, high quality. The company has won many honors and key high-tech enterprises in Tianjin, China has built 8 regional sales offices, has built a nationwide marketing network.





您永远值得信赖的电气供应商。  
you never trusted electrical suppliers.

## 企业文化 CORPORATE CULTURE

### 企业精神 ENTERPRISE SPIRITS

严谨 CHARINNESS

创新 INNOVATION

认真 EARNEST

务实 DILIGENCE

### 营销理念 SALES CONCEPTION

为客户做好服务 TO SERVE THE CLIENTS WITH WHOLE HEART

与客户共同发展 TO REALIZE MUTUAL DEVELOPMENT

### 质量方针 QUALITY POLICY

诚实守信 精益求精 持续改进 用户满意

HONESTY AND RELIABILITY KEEPING IMPROVING CONTINUOUS IMPRVEMENTS







## 荣誉，成功的肯定 HONOR AFFIRMATION

荣誉在海森人眼里，  
是鼓励，更是鞭策  
荣誉代表过去，关键在于未来  
面对成绩，面对社会和客户的信赖  
海森人踌躇满志，征战未来

Honor in the eyes of the Heisen people,  
Is to encourage, but also spur  
Award represents the past, the key lies in the future  
The face of the achievements in the face of society and the  
trust of customers  
The Heisen people smug, expedition to the future

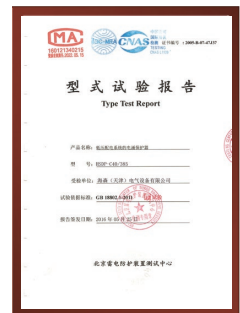
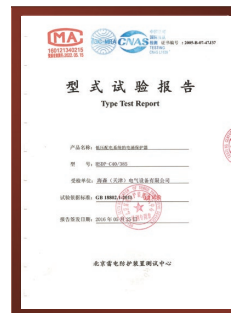
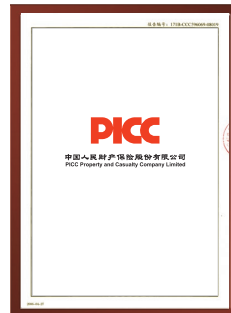

## 产品优势 Product advantages

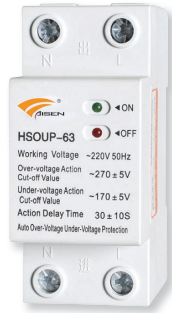

- ◆ 功耗低，负载能力强
- ◆ 安全可靠，寿命长
- ◆ 自动恢复式接通线路，无需人工操作。
- ◆ 线路出现瞬态或暂态过电压时，不产生误动作。
- ◆ 线路接点不实等电压不稳或突然断电又突然来电时，不接通线路；
- ◆ 线路故障电压为最高时，保护器自身不会被损坏；
- ◆ 呈反时限动作特性，动作时间  $\leq 1s$ ；
- ◆ 单相电压保护范围：0 ~ 290V；
- ◆ 耐受冲击电压：4kV；
- ◆ 具有工作状态指示，绿色：正常电压，红色：过欠电压或延时；
- ◆ 符合 III 类电器的安全标准；
- ◆ 外形模数化设计；
- ◆ 分离式，安装灵活；
- ◆ 导轨式，安装方便；

## 适用范围 Scope

HSOUP 系列自恢复式过欠电压保护器，适用于单相或三相交流电压，频率 50Hz，额定工作电流 100A 及以下的用户或负载。主要用于民用住宅配电箱进线或需要保护单相用电设备的回路中，作为由中性线故障引起的相线路过欠电压时，能保持高压冲击下迅速、安全地切断电路，避免异常电压送入撞断电器设备造成事故的发生，当电压恢复正常值时，将在 5 分钟自动接通电路。开关造型美观、新颖简洁，体积小、功能全，功耗低，负载能力强，安全可靠，寿命长。

## 符合标准 Standards compliant

GB14048.1-2006	《低压开关设备和控制设备》
GB14048.5-2008	《低压开关设备和控制设备》
JGJ 242-2011 6.3.2	《住宅建筑电气设计规范》
GB/T16895.10-2001	《建筑物电气装置》
III	符合 III 类电器的安全标准

## 工作条件

### Working conditions

- ◆ 环境温度：- 5°C ~ +40°C；
- ◆ 相对湿度：在最高温度 +40°C 时，空气的相对湿度不超过 50%，温度为 25°C 时，不大于 95%；
- ◆ 海拔高度不超过 2000m；
- ◆ 适用于污染等级为 2 及以下的环境，即一般情况下公有非导电性的污染，但可以预期偶然由于凝露造成的短暂的导电性污染

## 产品选型

### Product Selection

#### HS OUP - 40 / 1P+N

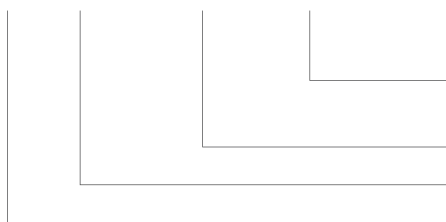

1P+N：单相 + 中性线

3P+N：三相 + 中性线

40：通过最大电流 20A、32A、40A、50A、63A、80A、100A

OUP：自动恢复式过欠压保护器

HS：海森电气

## 性能参数

### Performance parameters

产品图片	63A/1P+N						100A/1P+N		100A/3P+N					
	20A	25A	32A	40A	50A	63A	80A	100A	32A	40A	50A	63A	80A	100A
														
框架电流 (A)	63A/1P+N						100A/1P+N		100A/3P+N					
最大通过电流 (阻性) (A)	20A	25A	32A	40A	50A	63A	80A	100A	32A	40A	50A	63A	80A	100A
额定电压 (V) Ue	AC380V													
工作频率 AC50Hz	AC50Hz													
额定工作电压 (V) Ue	AC220V													
单相过压动作切断值 (V)	AC275 ± 5V													
单相过压动作恢复值 (V)	AC248 ± 5V													
单相欠压动作切断值 (V)	AC170 ± 5V													
单相欠压动作恢复值 (V)	AC183 ± 5V													
单相动作延时时间 (S)	30 ± 10S													
单相延时复位时间 (S)	≤ 1S													
单相耐受冲击电压 (KV)	4KV													
单相电气机械寿命	≥ 10 万次													
单相功耗	≤ 0.7W													
安装方式	导轨安装													

## 外形与安装 Outline and Installation

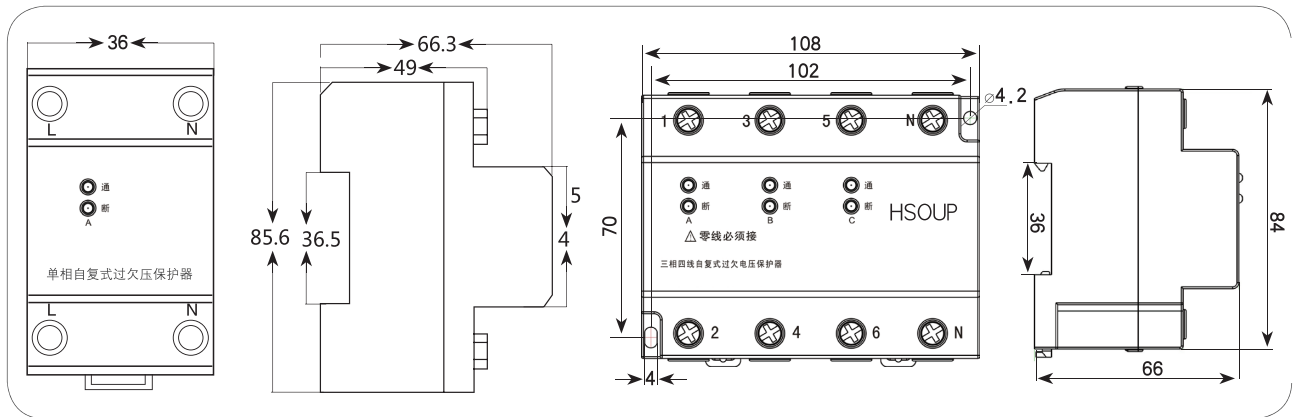

## 设计案例 Design case

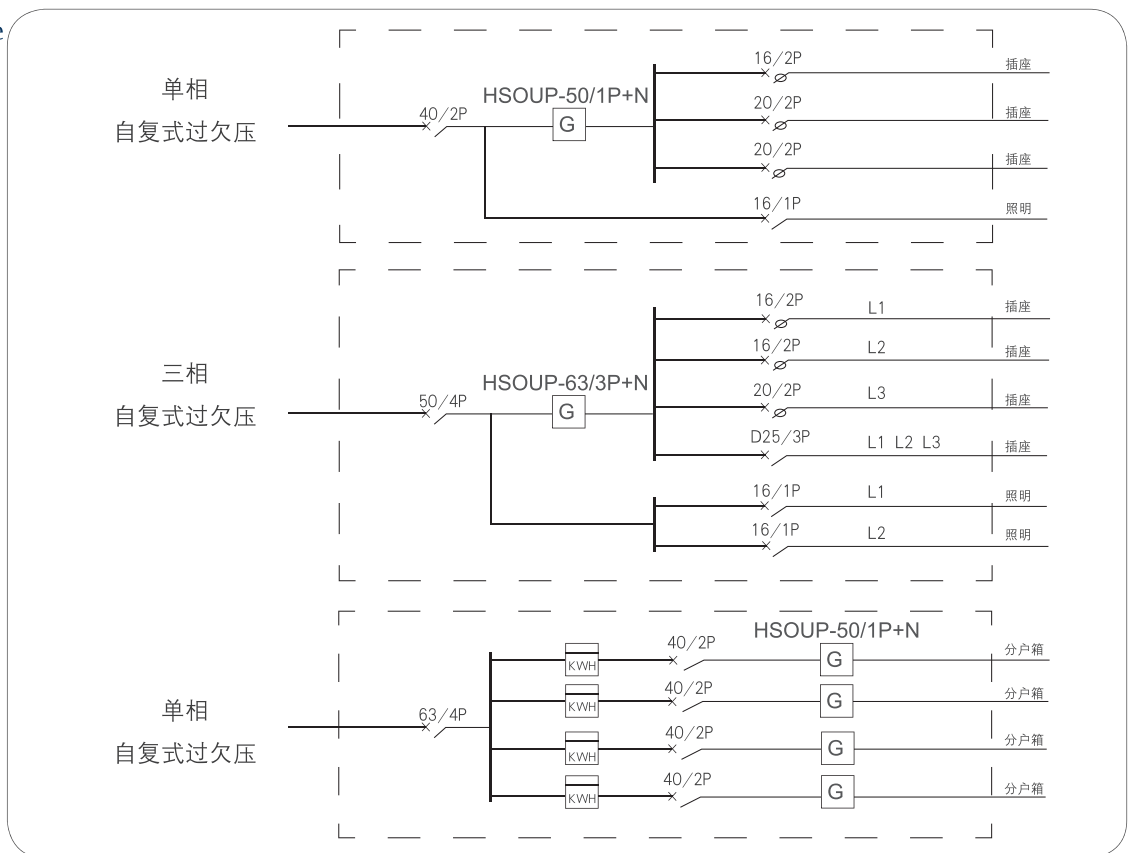

## 注意事项 Precautions

- 1、3P+N 的保护器为三相四线，零线必须安装；
- 2、保护器 N 线为零线，L 为火线，不得接错；
- 3、保护器第一次通电时需延时  $30 \pm 10$  秒后给负载正常供电；



部分工程案例  
Part of the project case

信赖的保证  
Trust of the guarantee

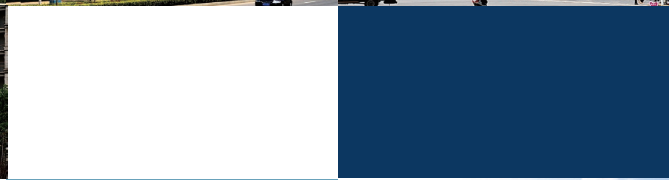

绿地地产

佳兆业集团

北京玫瑰坊

重庆绿韵康城

保利地产

碧桂园地产

北京国展新座

保利中心

绿城地产

中铁置业

南益名泉春晓

保利华庭

华润地产

天津市房地产

北京夏都家园

长春亚泰花园

中海地产

龙湖地产

鲁商盛景家园

上海宝山小区

金科地产

鲁商地产

上海路径上嘉苑

天津海琴广场

棠湖泊林城

南益地产

成都佳兆业广场

济南中央广场

成都棠湖泊林城

绿城玉兰花园

上海翠堤上郡

西安华润 24 城

天津中豪世纪花园

### 北京办事处

地 址：北京市海淀区中关村南大街 2 号数码大厦 B-2616 室

Address: Haidian District, Beijing Zhongguancun South Street on the 2nd Digital Building B-2616, Room

### 上海办事处

地 址：上海市虹口区四川北路 1666 号高宝新时代广场 A 座 1507 室

Address: Block A KBA Times Square, 1666 North Sichuan Road, Hongkou District, Shanghai, Room 1507,

### 广州办事处

地 址：广州市天河区黄埔大道西 76 号富力盈隆广场 809 室

Address: Tianhe District, Guangzhou Huangpu Road West 76, R & F Profit Plaza, Room 809

### 西安办事处

地 址：西安市西高新经济开发区二环南路 180 号财富中心 A 座 1225 室

Address: 1225 Room, Block A, of two Ring South Road 180, Fortune Plaza, West High-tech Economic Development Zone in Xi'an

### 重庆办事处

地 址：重庆市渝中区青年路 7 号时代豪苑 D 座 216 室

Address: Yuzhong District youth road on the 7th era Tropicana Gardens, Block D, Room 216

### 济南办事处

地 址：济南市天桥区北园大街 480 号国贸公寓 1429 室

Address: Flyover District of Ji'nan City Beiyuan Street No. 480 China World Trade Center apartment 1429 room

### 石家庄办事处

地 址：石家庄市桥西区中华南大街 62 号万豪大厦 1103 室

Address: Marriott Building, Room 1103, No. 62 South Street, Shijiazhuang Shiqiao Western

### 杭州办事处

地 址：杭州市西湖区文二西路 718 号西溪创意大厦 C-26

Address: Wen West Road No. 718, Xihu District, Hangzhou Xixi Creative Building C-26

### 海口办事处

地 址：海南省海口市琼山区朱云路 216 号 D 栋 104 室

Address: Qiongshan District Hainan city of Haikou province Zhu Yun No. 216 building 104 room D

**客户支持热线：4006-111-064**



地 址：天津市滨海新区津塘公路 89 号

Address: Tianjin Binhai New Area, Tanggu Road No. 89

邮 编：300450

Postal Code: 300450

<http://www.haisentj.com>

<http://www.haisentj.com>

E-mail: [tjhaisen@126.com](mailto:tjhaisen@126.com)

E-mail: [tjhaisen@126.com](mailto:tjhaisen@126.com)